



REV	DATE	RELEASED REVISION	DWN
A	01/08/2012	RELEASED	-
-	-	-	-
-	-	-	-

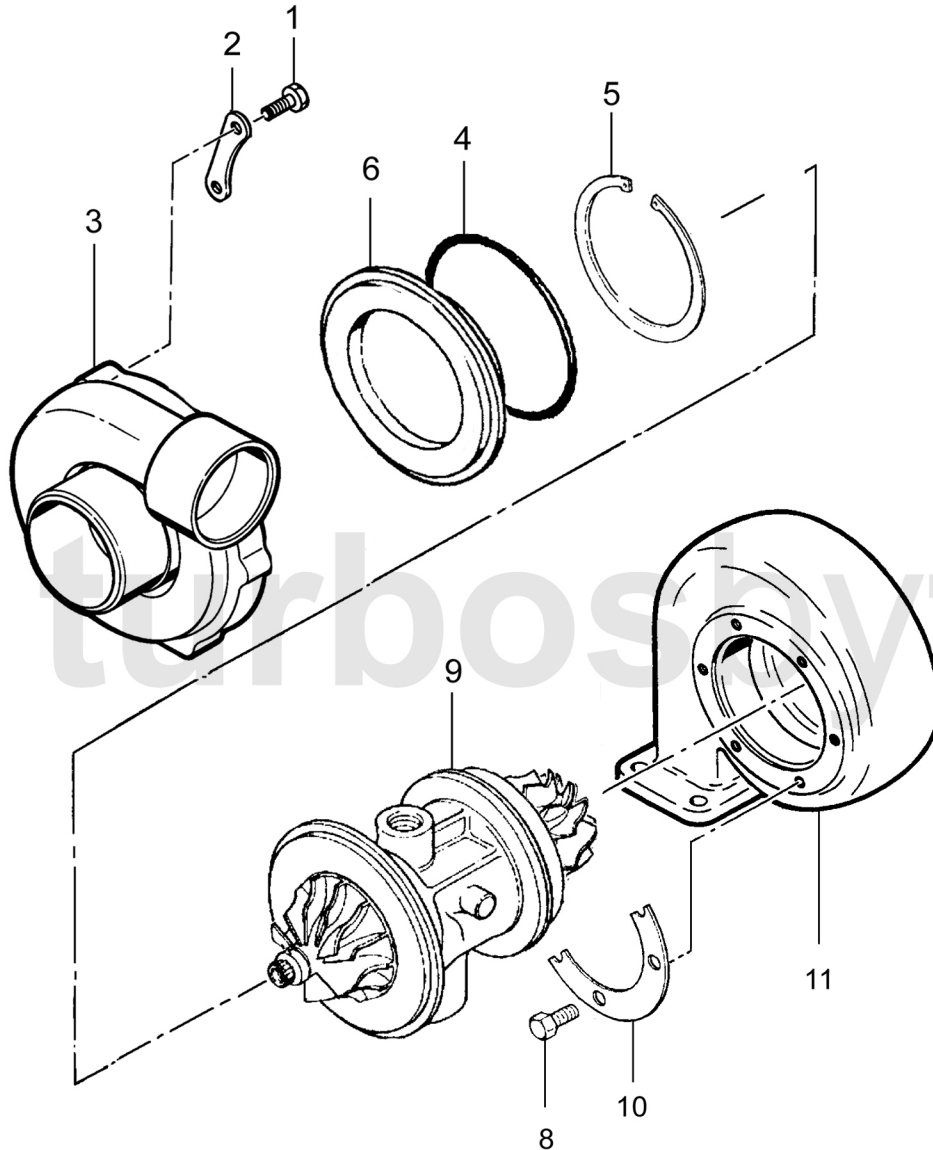
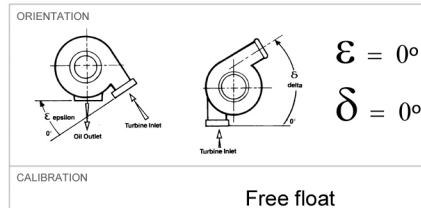

Fig	Description	Part number
1	Bolt x 6	400975-0303
2	Clamp x 3	407875-0000
3	Compressor housing	848253-0068
4	O-ring	403069-0164
5	Retaining ring	400589-0375
6	Adapter	448751-0001
8	Bolt x 6	400677-0816
9	C.H.R.A.	836012-5008S
10	Clamp x 2	449028-0001
11	Turbine housing	827690-0002

Note: Illustration for reference only, may not resemble actual part.



TITLE
GTX2867R Gen2

SIZE A	PART NO. 856800-5006S	REV A
-----------	--------------------------	----------

MATERIAL	DRAWN: ACS	DATE: 18/10/2016	CHECKED:	SHEET: 1 OF 1
----------	---------------	---------------------	----------	---------------