

**Compressor Inlet**  
HOSE CONNECTIONS  
TABULATED AS (Ø x L)

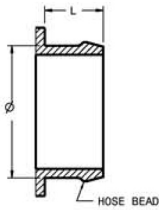

Ø 103.6 x 31.75

**Compressor Outlet**  
HOSE CONNECTIONS  
TABULATED AS (Ø x L)

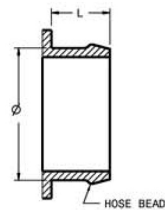

Ø 50.8 x 30

**Oil Inlet**

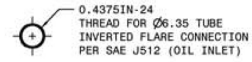

**Turbine Inlet**  
"T3" PN74902-1, 2, 3, 7, 8, 9

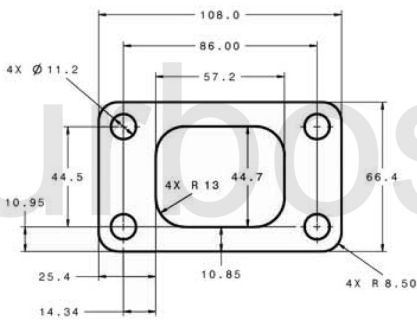

"T4 UNDIVIDED" PN740902-13, 14, 15

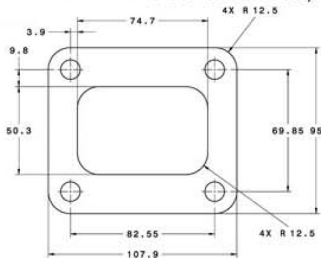

**Turbine Outlet**  
"3-INCH 4 BOLT" PN740902-1, 2, 3

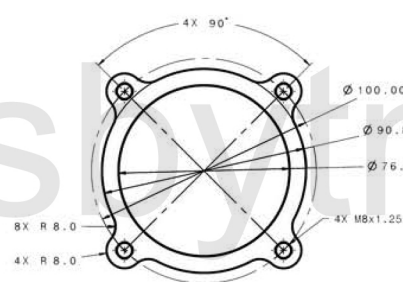

PN740902-7, 8, 9, 13, 14, 15

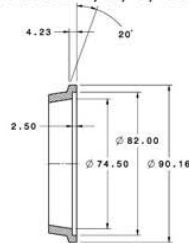

**Oil Outlet**

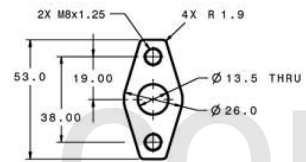

**Water**

M14 x 1.50

