

Compressor Inlet
HOSE CONNECTIONS
TABULATED AS (Ø x L)

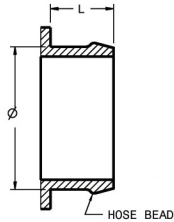

Ø 69.85 x 31.75

Compressor Outlet
HOSE CONNECTIONS
TABULATED AS (Ø x L)

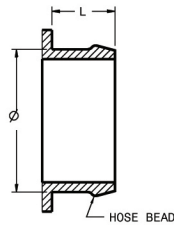

Ø 50.8 x 30

Oil Inlet

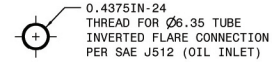

Turbine Inlet
"T25"

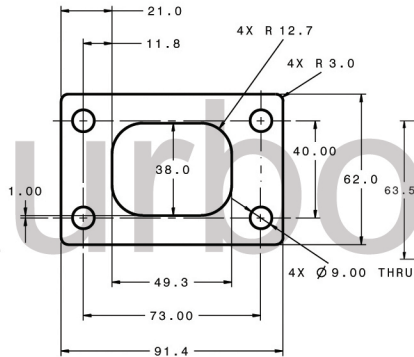

Turbine Outlet
"5 BOLT"

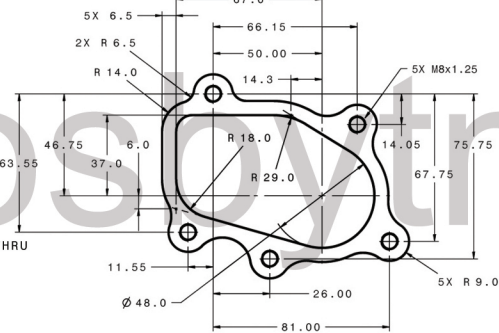

Oil Outlet

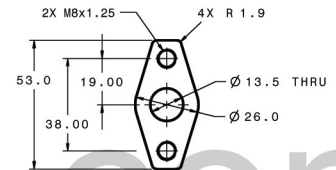

Water

M14 x 1.50

